

# Medical technology Products

Made in Germany



**LISCHKA**<sup>®</sup>



## Our company



Founded in 1993 in Berlin, Lischka GmbH has since established itself as a proven manufacturer of high-quality care and hygiene technology as well as medical furniture. We support our customers competently and reliably from the first consultation through delivery and installation to the necessary maintenance. Our standard-compliant production takes place according to the specifications and wishes of our customers. We develop and implement tailor-made complete solutions that match your specific requirements and accompany you flexibly through your procurement process.

## An experienced team

Experience and quality belong together. For this reason, only experienced and highly trained specialists who have learned their work from the bottom up and who also offer the right solutions for complex tasks work in our company. This is particularly important in our profession, because not only the highest hygiene and quality standards need to be adhered to; tailor-made concepts are always required. With the Lischka GmbH team you always have the security of receiving all services from a single source, because we are a system provider with extensive manufacturing expertise.





## Development milestones

- 1993 Founding of the company by Mr. Leonhard Lischka.
- 1995 Certification according to ISO 9001.
- 2003 Purchase of a stainless steel Furnishing manufacturer. Development of the product line and sales of stainless steel and powder coated steel sheet furnishings for the healthcare industry.
- 2007 Purchase and complete revision of the Bedpan Washer segment from Belimed. Certification of the devices according to EN ISO 15883-1 and -3.
- 2008 Sales of CDD 1050, CDD 1060, CDD 1090 Cleaning and Disinfection Device as certified devices under the "Geysir" brand name.
- 2010 New brand identity „made by LISCHKA Germany“.
- 2011 Fan support for the closed recooling system for the Geysir receives patent approval.
- 2017 Relocation to a newly built production and administration building.
- 2018 Development of the ProEndoDryClassic endoscope storage and drying cabinet according to DIN EN 16442.
- Today Maintaining and consistent Continuation of all certificates.



## Geysir Series -

### High quality Cleaning and Disinfection Devices

Our innovative “Geysir” bedpan washers convince with a high technical level and perfect functionality. Their purchase assures you a great ROI due to their long life cycle and low energy and water consumption. And of course, they meet the highest hygiene standards. In addition to all the necessary standard certifications our devices have certifications against Covid-19 and Clostridium Difficile.



#### **CDD 1050** (WxDxH: 500x450x1775mm) ■

- A user friendly, space-saving device with a large washing chamber and an ergonomic loading height of 900mm
- Compliance with the latest hygiene regulations
- Wide range of standard and optional features such as: automatic door opening & closing (via foot pedal and/or sensor), automatic disinfection of the devices pipping system if prolonged inactivity or at a preset times



#### **CDD 1060** (WxDxH: 600x560x900mm) ■

- Our most compact, space-saving device with nonetheless a surprisingly large washing chamber
- Used as a stand-alone or under counter unit
- Can be used as a sluice sink



#### **CDD 1090** (WxDxH: 900x560x900mm) ■

- Stand alone or under counter device with a large washing chamber
- Used as a stand-alone we can integrate a sink 370x350x150mm in the cover. It can also be used as an under counter unit
- Can be used as a sluice sink

## Individual and customised solutions

At Lischka, you get the perfect combination of bedpan washers and medical furniture.

Our Geysir work care combinations combine modern hygiene for wards and work rooms in clinics or nursing homes. They are characterized by their high quality and solid construction and are available in numerous combination variants. The maintenance-friendly, easy-care surfaces are ideally suited for high loads and are available in finely polished stainless steel or electrolytically galvanized sheet steel with a disinfectant-resistant plastic coating made from melted paint powder. For demanding hygiene concepts, we offer a coating with an antimicrobial effect. Another plus point is the wide range of shapes and color adaptations to the desired room and color concept.





## Endoscope storage systems **ProEndo**

With ProEndo you are choosing to store cleaned endoscopes and bronchoscopes in accordance with standards. The fully extendable storage slide enables the endoscope to be suspended and removed in front of the cabinet. The special endoscope dangling protection ensures that the ends of the endoscope can be fixed easily and safely. Another advantage is that the ProEndo pull-out is only mounted on the cabinet roof, so that the entire cabinet interior can be cleaned and disinfected without any problems. ProEndo offers the possibility of storing up to four endoscopes, bronchoscopes or TEE probes without damage on a unique free-swinging, fully extendable telescope slide.





## Endoscope storage cabinet **ProEndoDryClassic** According to DIN EN 16442

Our ProEndoDryClassic endoscope storage cabinet is the right choice for intermediate or final drying of the individual endoscope channels. This enables endoscopes and bronchoscopes to be stored in accordance with the RKI guidelines. ProEndoDryClassic has a drying function in accordance with DIN EN 16442. The devices are dried using sterile air. An integrated control system ensures that all standards are met. With us you are also in the best of hands for special solutions for endoscope reprocessing. We would be happy to advise and inform you!

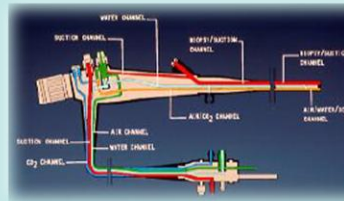

Individual inner-channel drying of endoscopes via Hepa filtered air

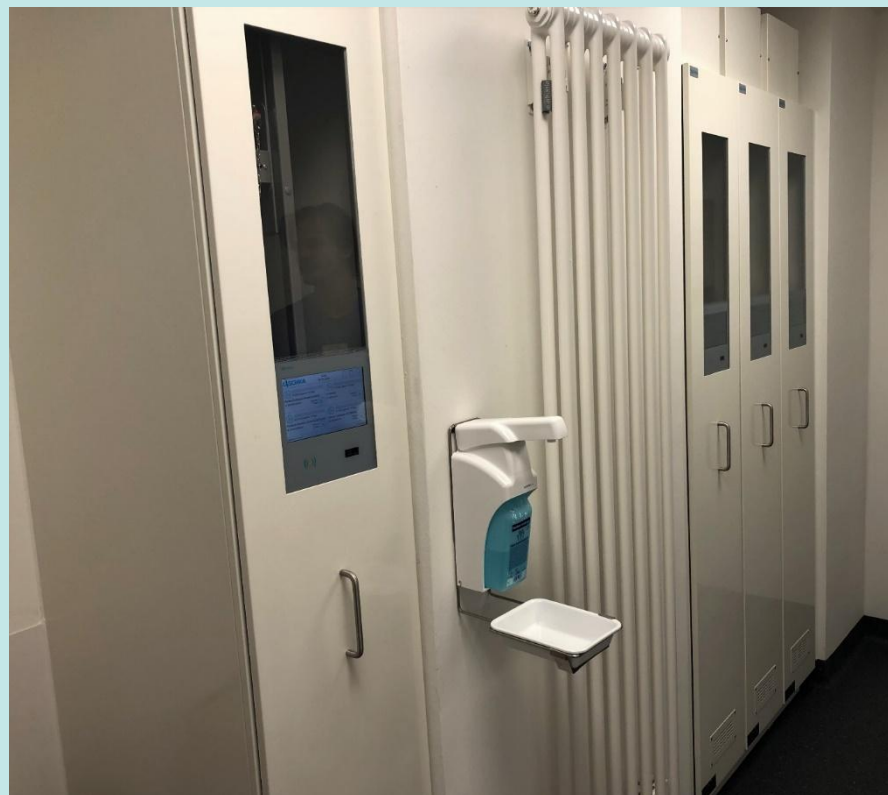



## A clean solution:

### Central Sterile Services Department (CSSD)

ProClean protects the health of the user during the pre-cleaning of instruments or endoscopes. The system is characterized by good functionality, practicality and hygienic handling. With the vertically movable protective hood ProShield M, the cleaning sink can be used in such a way that the hood does not have to be touched. It is operated using a foot switch or button. The humid and aerosol-contaminated air extracted with ProClean Air is passed through a 2-stage filter system after it has been dehumidified. The harmful substances are safely filtered out of the polluted air in the cleaning sink before it is released back into the environment.

The surfaces are made of stainless steel or powder-coated sheet steel (optionally also antimicrobial). Numerous combination variants are available so that the user always gets exactly the solution he needs.



## ProPack: Custom made packing tables

The ProPack packing tables are equipped with a maintenance-free, electro-hydraulic height adjustment and impress with their ease of use. With a centimeter-accurate display of the working height, the packing table can be precisely adapted to the needs of the user. The table frame is made of stainless steel or powder-coated sheet steel. Numerous combination variants - from the equipment to the color to the accessories - are available so that they can be adapted to the respective requirements.



## State-of-the-art manufacturing processes



From simple metal sheets to the finished product, we cover all work processes in our ultra-modern production facility. Thanks to our high level of vertical integration, we can carry out all steps ourselves. We always observe the highest hygiene standards. We manufacture with the highest precision and care. Whether cleaning and disinfection equipment or medical furniture: products and processes are subject to strict quality control.

We have the latest CAD / CAM software at our workstations. The metal sheet cuts are made using powerful Trumpf CNC machines. This ensures the highest dimensional accuracy at all times. Bending or folding also takes place on CNC-controlled hydraulic Trumpf press brakes.

## Equipped for the future

Lischka continuously invests in the modernization and expansion of the machine and plant park. With our modern machine park, which also includes special punching and bending machines as well as drilling, milling, turning and grinding machines, we are able to provide customer-specific detailed solutions. In our assembly area, the prefabricated metal sheet parts are connected to one another and equipped with the respective accessories such as furniture fittings, seals, locks and other components. Since all processes are perfectly coordinated, we can always guarantee efficient, economical and safe processes.

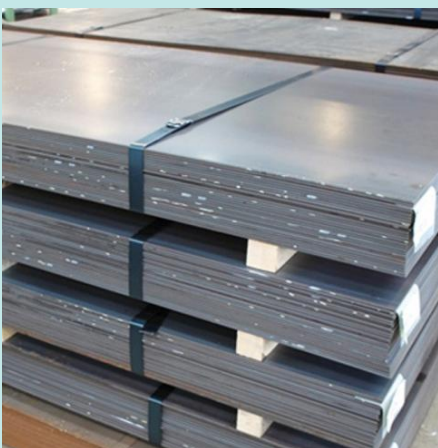

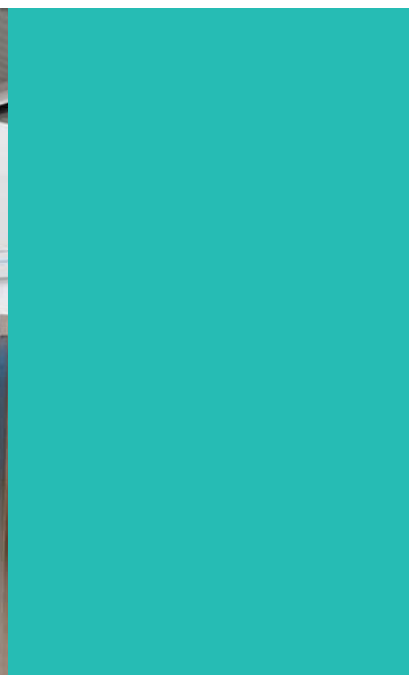

## From the Idea to the Concept

Thanks to our modern technical equipment and our extensive technological know-how, we are able to implement all customer requests down to the last detail. At the beginning of a project, there is always competent advice including tailor-made project planning. Our specialists will be happy to provide you with advice and assistance.

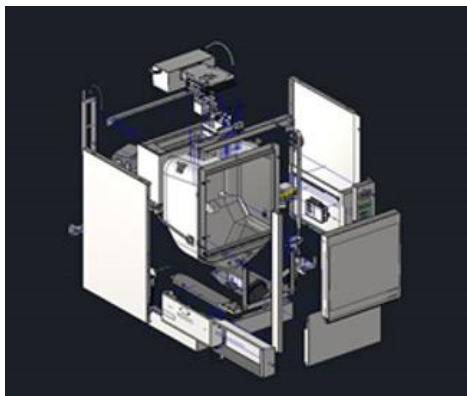
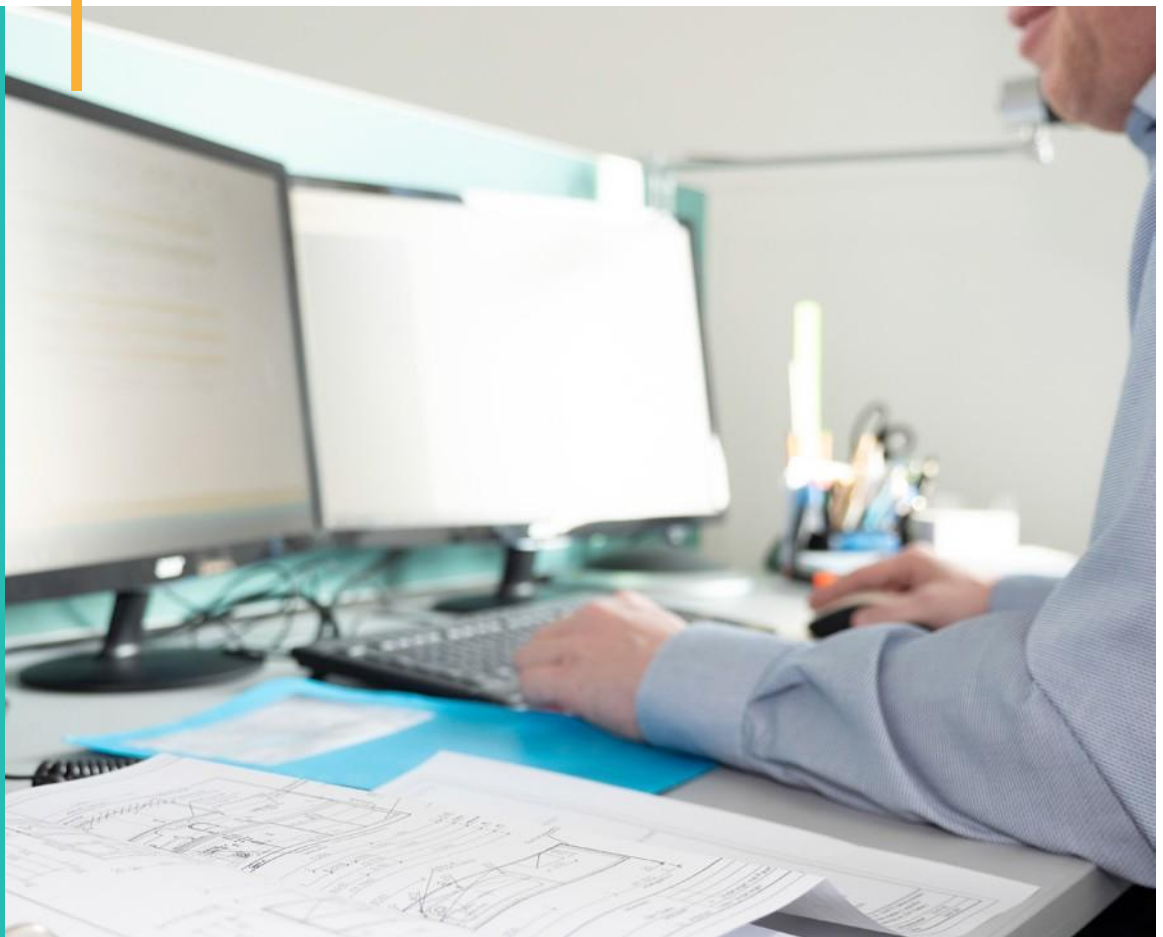

## You can count on us

Our project management ensures that your idea takes concrete shape with the help of the latest CAD programs. On the basis of precise situation analyzes and feasibility studies, we are able to implement your wishes and requirements. From the first consultation to assembly and beyond, we are committed and reliable at your side. You can rely on it - since 1993!





## ProLine Series

### ProLine Color

Lischka's portfolio also includes electrolytically galvanized, powder-coated steel furniture according to the EURO and ISO standards for clinics, practices and nursing homes. The ProLine Color series has a melted plastic coating that meets the high requirements for decontamination in hospitals. Furthermore the surface is maintenance-friendly, easy to care for and resistant to common disinfectants. The furniture in the ProLine Color series is made up of individual moduls and is therefore protected against corrosion.



## Flexible solutions

### ProLine Stainless Steel

The stainless steel furniture in the ProLine Stainless Steel series is made from stainless steel (CNS), material 1.4301. The surfaces are sanded to 400 grit in a special duplex sanding process. The surfaces made of grain 320 are sanded to a satin finish. The material used impresses with its high quality and durability. Further advantages are the surface hardness with a high resilience against scratches and bumps as well as the resistance against chemicals. The even fine grinding gives the stainless steel a high-quality appearance and offers the best protection against contamination.



## Medical furnishings

### Heating cabinets

Lischka medical furniture is the perfect solution for all areas in which instruments and equipment need to be heated up in hospitals. Blankets, towels, clothing, infusions, contrast media or instruments: all objects and resources are brought to the required temperature using circulating air. A digital temperature display is integrated in the front for safe processes and controlled heating. The thermostat is continuously monitored so that the highest level of safety is guaranteed. The design of the medical furniture can be freely selected: with drawer or door, with shelves, as a stand-alone version as well as a built-in version - also suitable for wooden furniture.



# Medical furnishings

## Instruments

The universal storage system enables the perfect storage of scissors of various sizes and shapes and can therefore be adapted to your individual needs again and again.



## Following you from A to Z Worldwide

A wide-ranging support that leaves nothing to chance is the basis for customer satisfaction.

We do not make any compromises and consciously set the bar high. We are therefore present for you worldwide via our network of trusted partners. In every country where we have a representation, you can rely on our partners well trained staff to advise you on our product line.

We organize regular sales and technical trainings for them so that they are up to speed on our ever evolving product range. This enables them to know how to execute flawlessly on installations, service or maintenance of our entire product line.

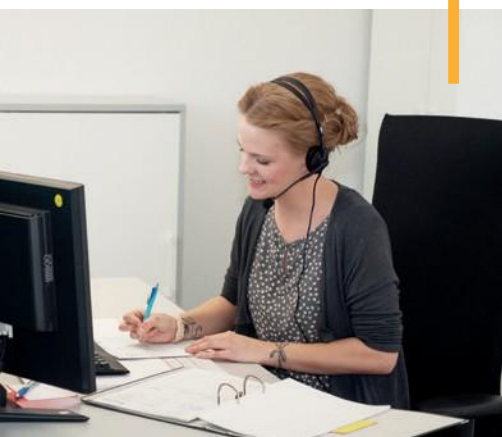

### Our services at a glance

- Maintenance
- Validation of medical facilities
- Safety checks
- Testing of electrical safety
- Repairs
- Thermoelectric check acc. EN ISO 15883
- Microbiological testing
- Detergent service check



From Germany to the world



Lischka GmbH

Boxberger Straße 19 | 12681 Berlin

Telephone: +49 30 981958-0 | Fax: +49 30 981958-200

info@lischka.berlin | lischka.berlin



2023-06-06\_Rev2