



BEDPAN WASHERS



CDD 1050



CDD 1060



CDD 1090

Cleaning and Disinfection Devices

made by **lischka** Germany



ENGLISH VERSION

Rev.1 (06.02.2023)



Easy handling: programs are started by pressing the keys on the interface. The A0-value for disinfection (from A0-60 to A0-3000) is also easily adjustable directly on the interface. As for the program sequence the operator can clearly follow it on the LCD display.

Hygiene & security: The special design of the chamber door significantly reduces heat emission and guarantees a very low operating noise level so that the machine does not disturb the patient. To protect personnel from steam burns, the chamber door is only released when the temperature in the washing chamber has reached a preset level.

Durability: The outer casing of the device is made of AISI 304 stainless steel (Grain 400). The washing chamber and inner chamber door of electrolyzed AISI 316 Stainless steel. This ensures more durability over the years.

Complete emptying: According to *EN ISO 15883* the water tank, pumps and tube systems are emptied automatically at the end of every cycle thus avoiding any recontamination.

LOW OPERATING COSTS:

Not only can you expect your investment to last you 20 years but these devices have extremely low maintenance costs

- No Hepa filter
- No rubber seal around chamber door but a self-disinfecting labyrinth seal

24 system disinfection:

For even more hygiene and security CDDs can self-disinfect at any preset time of the day. If the CDD was not in use for more than 24 hours, the device can run a complete pipe and nozzle disinfection before being used again.

Sizes, variants, all types of combinations...

The innovative bedpan washers of the Geysir series are available in device widths 90 cm, 60 cm and 50 cm. Depending on the model, they can be used as built-in, wall-hanging, free-standing, or under-bench and come in all configurations (automatic doors, pump for descaler and/or detergent, autostart, etc...)

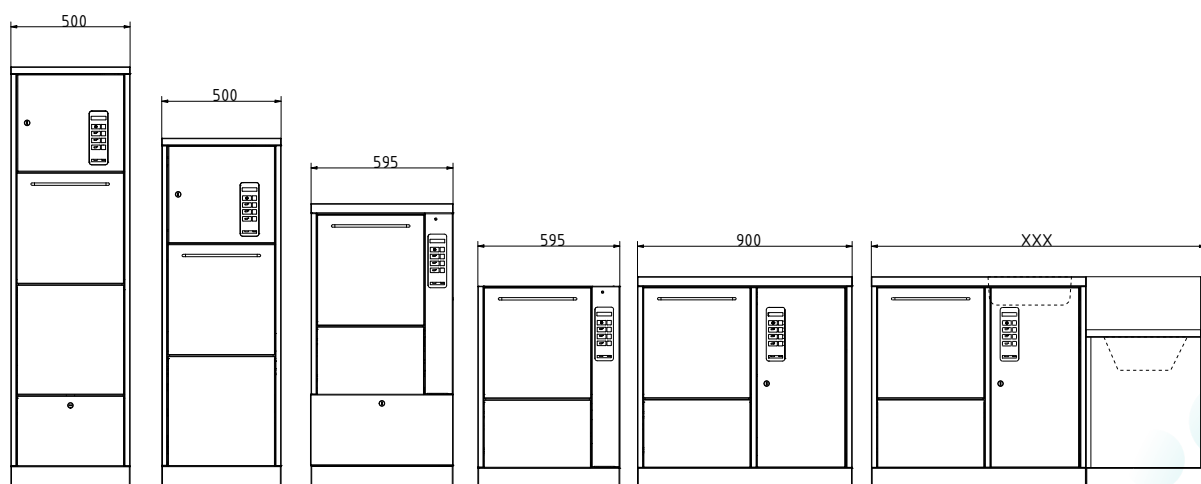

PATENT

Cleaning and Disinfection: The clever arrangement of the multifunctional power nozzles combined to the high-capacity pump guarantees the energy-efficient cleaning and disinfection of all goods.

Protection: our patented recooling system protects your patients, your staff and your facility. At the end of the disinfection phase, our patented system cools the air loaded with steam so that when staff opens the chamber door, there will be no steam left in the chamber and therefore no room pollution by aerosols. This also means that unlike some competitors, we do not pull the hot air into the piping/the building walls, which causes condensation.

Customized solutions

We offer the perfect combination of bedpan washers and medical furniture.

Our Geysir sluice room units, combine high level hygiene with perfect functionality for work rooms, in hospitals, clinics or nursing homes. They are characterized by their high quality and solid construction and are available in numerous combinations (material, shape and color).

The maintenance-friendly, easy to care for surfaces, are ideally suited for high workloads and are available in finely polished stainless steel or powder coated electrolytically galvanized sheet.

Complete Sluice rooms



Built-in CDD

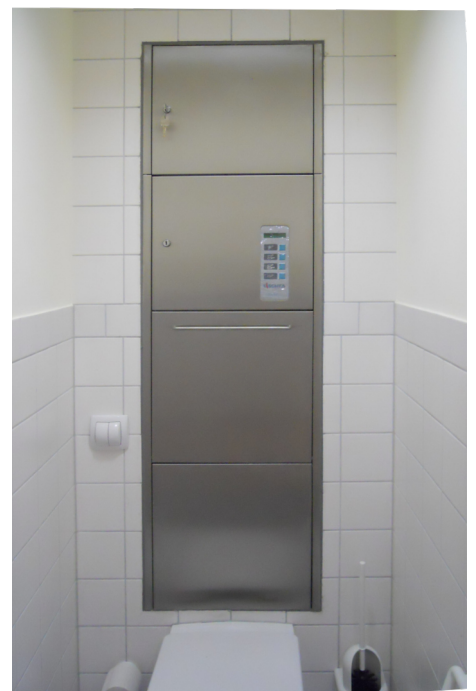

Certified against...



All our devices can be equipped with special programs against **Clostridium Difficile** and Viruses (**Covid19** and **Norovirus**),



Their efficiency was tested and certified by an independent laboratory.

If you already have one of our machines, a special Kit can be installed to upgrade your machines with this feature.

New
Certified programs against:

- **Clostridioides difficile**
- **Noroviruses**
- **Coronaviruses (including Covid 19)**

Available as an option on all our devices.

 Certified  Upgradable  selectable direct on the device

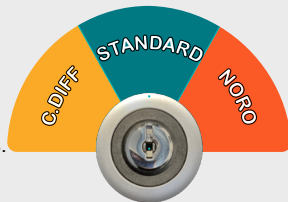

Universal holding frame

Multifunctional
for a wide range of containers

Simple
to use

In order to make the units even more user-friendly we developed the universal holding frame. It offers the highest degree of operating comfort and safety to staff using the machine.

This user-friendly frame, with flawless hygienic locking straps, can accommodate the most varied utensils of everyday clinic and nursing-home life and if required, can quickly be exchanged without the need for tools.

All goods to be washed are emptied hygienically and with little odor as the operator closes the door. This ensures more hygiene, security and less odorous nuisance.. The ingenious flushing geometry of the washing chamber, ensures consistent and optimal cleaning and disinfection.

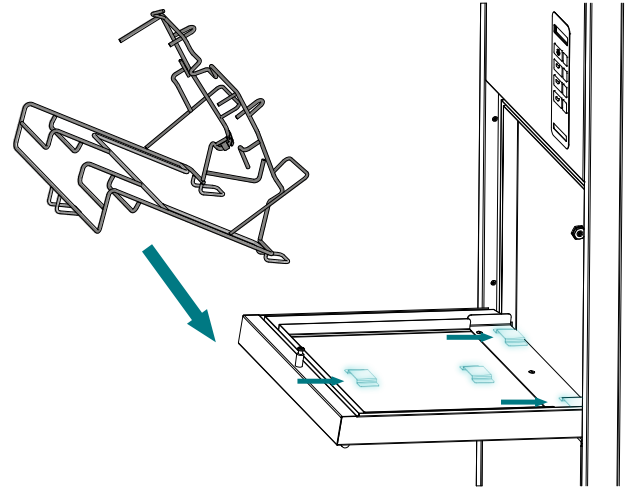

Easy slide-in mechanism



Options

Geysir-Cut

Urine bag cutter

Increase the ROI of your Cleaning and Desinfection device!

With Geysir-Cut, you can desinfect urine/secretion bags and reduce your disposal waste costs.



Special Holders

Tray for small items



for 12l bucket



Basket for small parts



for suction bottles



Our mission:

To contribute globally to the quality enhancement and affordability of infection control within the healthcare industry.



Lischka GmbH
Boxberger Straße 19
12681 Berlin Germany
info@lischka.berlin

Tel.: +49 30 98 19 58 - 0
Fax.: +49 30 98 19 58 - 200
web: www.lischka.berlin